

STAINLESS STEEL MIRROR WP604



700 x 500 x 1 mm

- Mirror in robust, germ-reducing and easy-care stainless steel mirror sheet metal (AISI 304).
- Mounting: With four Torx® locking screws.
- Delivery includes fixing material.
- Weight, including single package: 2.8 kg
- Other dimensions available upon request.



Suggested text for specifications:

Mirror in stainless steel mirror sheet metal (AISI 304) for surface mounting. Delivery includes four Torx® locking screws.

Dimensions: 700 x 500 x 1 mm

Article No. WP604

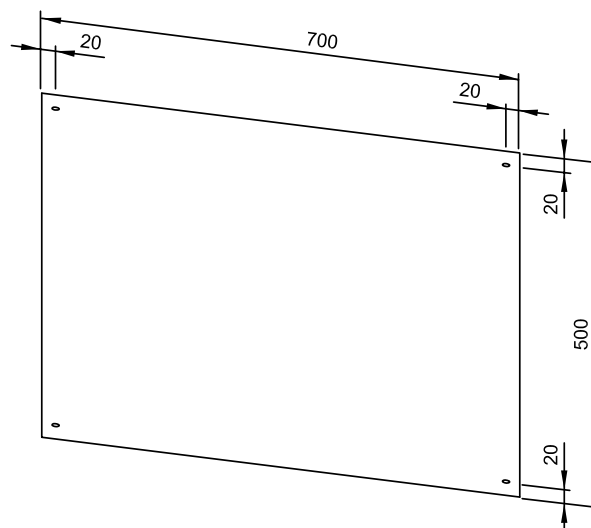

Available surface	ID No.
Mirror sheet metal	727 875

Ernst Wagner GmbH & Co. KG

Ernst-Abbe-Straße 21 · D-72770 Reutlingen · Tel.: +49712151539-0 · Fax: -20
info@wagner-ewar.de · www.wagner-ewar.de

WAGNER
E W A R